

**NAM ANH GROUP**  
Technological Orientation To Make Difference

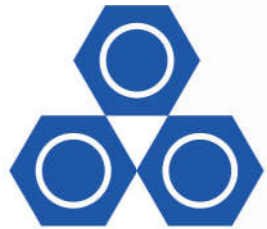

**NAM ANH GROUP**  
Technological Orientation To Make Difference

[www.namanhgroup.com](http://www.namanhgroup.com)

Tel: +84 8.62586436

Address: Floor 3, Vuon Dao Building, 689 Lac Long Quan,  
Tay Ho District, Ha Noi, Viet Nam

## CONSTANTLY CREATIVITY

Persistence, effort, nurturing aspirations  
Safety – quality – sustainable development



## GREETINGS FROM GENERAL DIRECTOR

Dear Customers!

On behalf of management board and all employees of the company, Nam Anh Technology Construction Equipment Co.,Ltd (Nam Anh) would like to send a warmly greeting and the most sincere thanks to all of our partners because of what you have been giving us in the past period.

Operating since 2008, we have had many years of experience regarding to supplying material, supplying and installation equipment, systems with diversity solutions about technology for construction project in civil construction & indistry, infrastructure sectors. We always do guarantee to supply products and technological solutions with the best of suitable for our participation projects. Thanks to all programs comprising of study, co-operation, and technology transfer with our foreign partners, we have been continously providing products & technology solutions having high utilities in order to satisfy the increasing in demands and diversity of our partners & clients. By our striving to do R&D process and provide the best consulting services throughtout of project implementation progress, we have been creating the best of core value for our clients.

Becoming the professtional company& achieving the success of today, we have been deeply understood that these things come from striving, creativity, unite of our management board and contingent of employees as well as the giant support, co-operation of our foreign & domestic partners for us.

Our ambitious task is to become increasingly profesional & diversity company regarding to supplying, installation high-tech application products for construction industry and performing research about the investment of production lines to gradually replace the import goods & equipment.

On behalf of management board, I am grateful for your value support during the past period, especically my partners, colleagues, customers those who have been greatly contributing to the development of Nam Anh.

Sincerely your

General Director

DOAN MINH NAM



## MISSION

**For customers:** we commit to become your trusted partner, together cooperation to create sustainable value. The most advanced, quality, unique of solutions & technologies to maximum satisfaction about requirements from our partners & customers are our reason to be.

**For employees:** we create the professional, creativity, high income environment, and fair development opportunities for all of employees.

**For society:** we bring the harmony between organization's benefits and society's benefits, actively contribute to activities towards the community, and illustrate our responsibility as well as national pride.



## VISION

By the passion, aspirations, and the strategy for building a sustainable business. Nam anh group constantly striven to becoming a prestigious brand at domestic and abroad as well.



## CORE VALUE

- Constantly creativity
- Persistence, effort, nurturing aspirations
- Safety - quality - sustainable development

# DIAGRAM OF ORGANIZATION

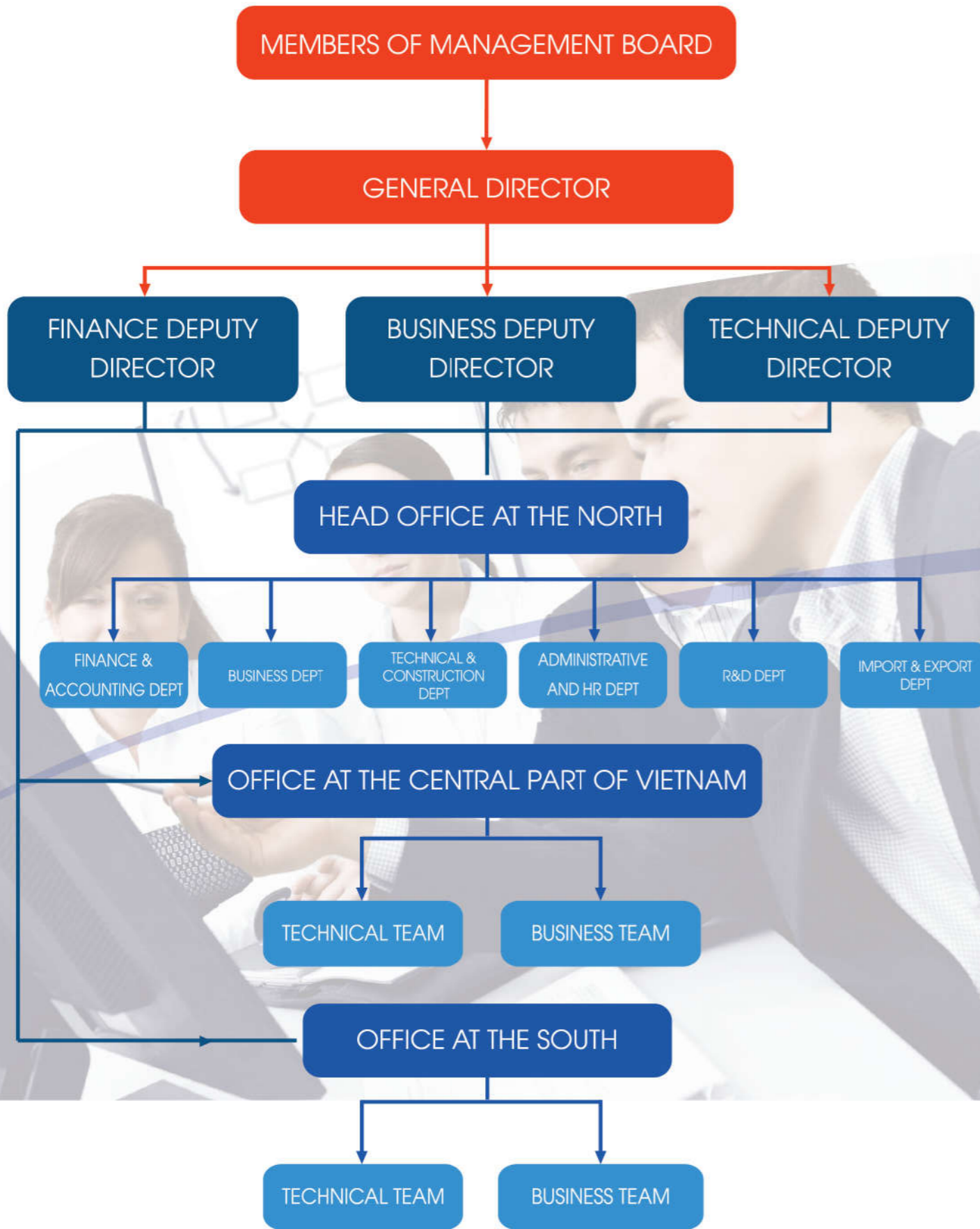

# THE MAJOR BUSINESS

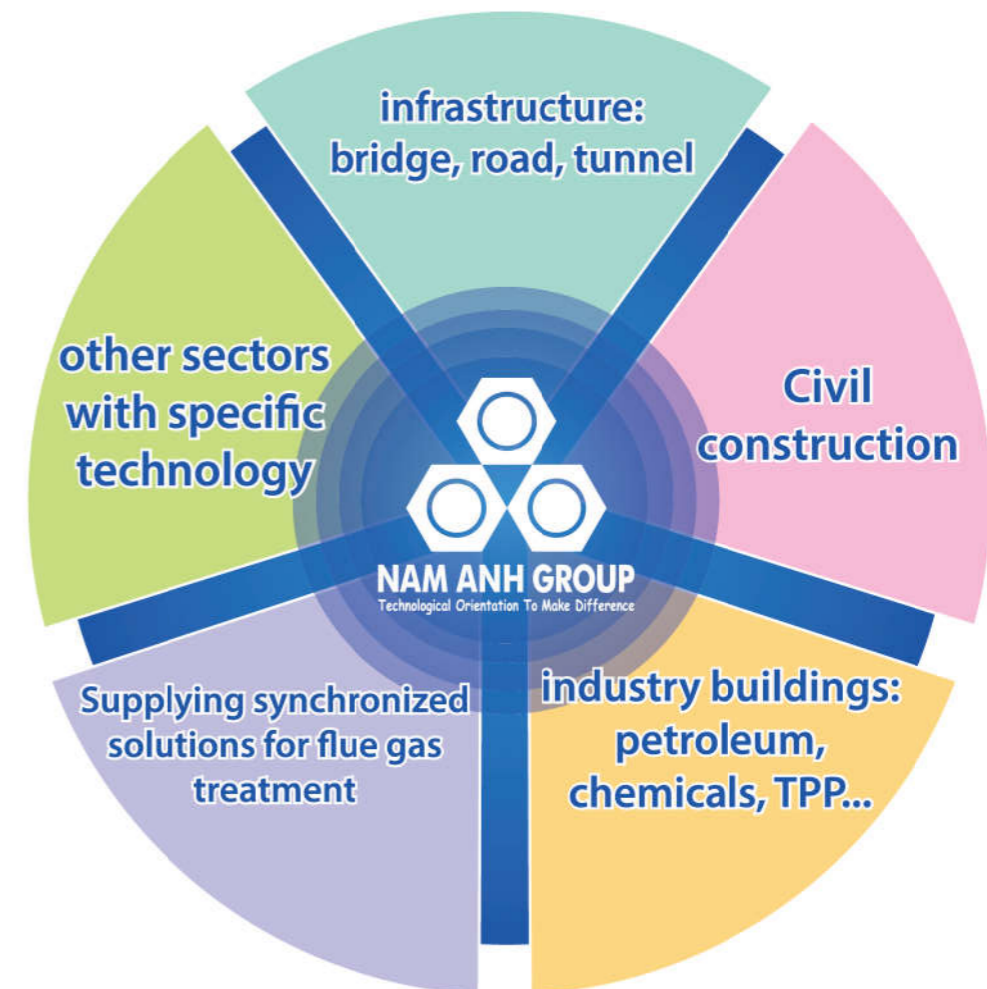



## “ Nam Anh Technology Construction Equipment Co., Ltd was founded on 27.10.2008”

### 2008 – 2009:

#### COMPANY FOUNDATION & ORIENTATION OF PRODUCTION AND BUSINESS

- Development of commercial field, supplying imported devices and equipment for construction works.
- Fastener productions are the first product that was researched and developed that distributed to retail market and projects; gradually expand and invest warehouse system and supplying network.

### 2000 – 2011:

- Expanding human resources and business scale.
- Concentrating on research and development (R&D), diversified supplying devices and equipment for transportation project, especially road and bridge, railway sectors.
- Participating in 2 major typical transportation projects are Vinh Thinh Bridge and Dong Tru Arch Bridge, opening up the opportunity to joint the next major projects.

### 2012 – 2017:

- Establishing representation office at Central, South of Vietnam; widening the market and participate in local projects.
- Intensive joining to the major transportation construction and fabrication project from North to South such as Dragon bridge (Da Nang), Dong Tru bridge (Ha Noi), Tra Ly bridge (Thai Binh), Bach Lam bridge (Yen Bai), Ha Noi – Hai Phong Expressway, Ha Noi – Lao Cai Expressway, Rach Chiec bridge (Ho Chi Minh City), Co Chien bridge (Tra Vinh), Cao Lanh bridge (Dong Thap), Vam Cong bridge (Can Tho), Ben Luc - Long Thanh Expressway ... Nam Anh Co., Ltd that is gradually asserting is reliable technology partner for customers in high

- tech projects such as steel arch bridge, cable – stayed bridge, extradosed bridge, suspension bridge;

Improving the company's synchronous capacity from technical consultant, supply, construction and product warranty, maintenance.

- Joining to supply equipment and devices for civil and industrial construction projects such as Thai Binh thermal plant No. 1 & 2, Long Phu thermal plant, Song Hau thermal plant; Viettin Bank Tower, Military broadcasting center...
- Continuing to improve R&D capacity and cooperate with foreign technology partners to more intensive participating in construction and fabrication projects; orienting technology methods to “make differential value” and “environmental friendly”

### 2018:

- Remark 10-years milestone of formation and development, Nam Anh Co., Ltd has been achieving significantly success.
- Continuing to make varied technology methods for material, application system for construction and fabrication from transportation to civil and industry.
- Researching production and investment cooperate with foreign reliable partners for technology product, gradually replacing imported goods.

# FIELD OF ACTIVITY



**NAM ANH GROUP**  
Technological Orientation To Make Difference

Transportation infrastructure is especially important in economic - social development, promoting connection - cooperation closer in the region, connecting regional market with national and international market, also realizing the economic potential of regions, improving effective in investment, developing production, business. Therefore, developing transportation infrastructure synchronously and modern is urgently requirement of our country now. Nam Anh group is glorious and proud to be a professional corporation in supplying materials, equipment, services and construction methods of infrastructure works like roads, railway, civil and industrial construction in Vietnam.

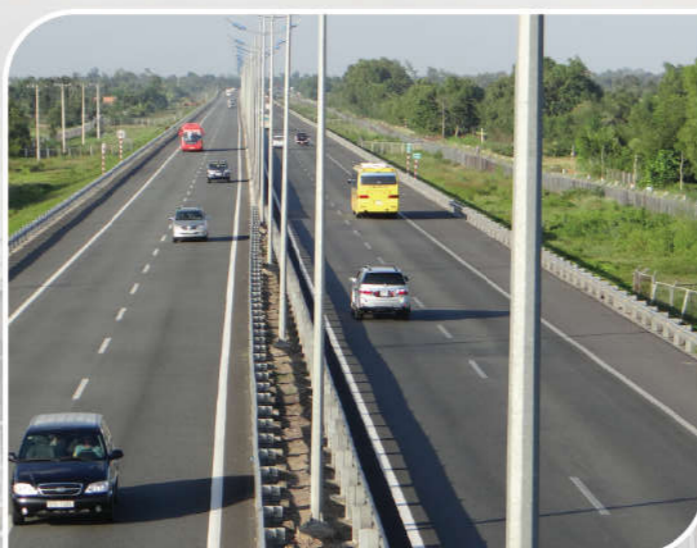
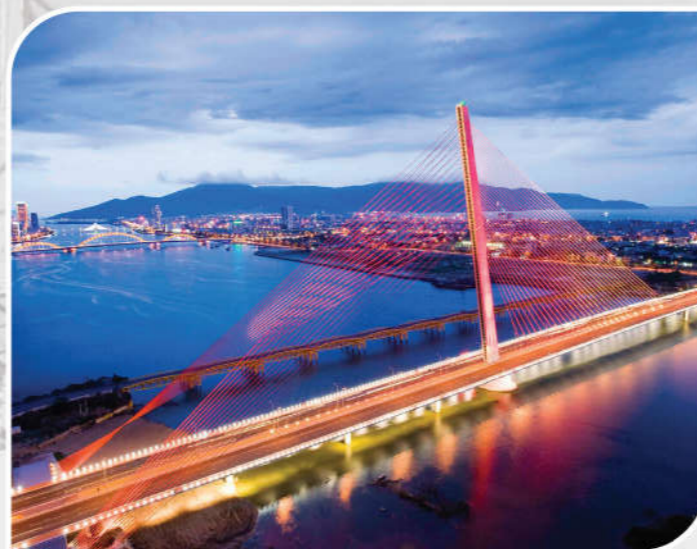
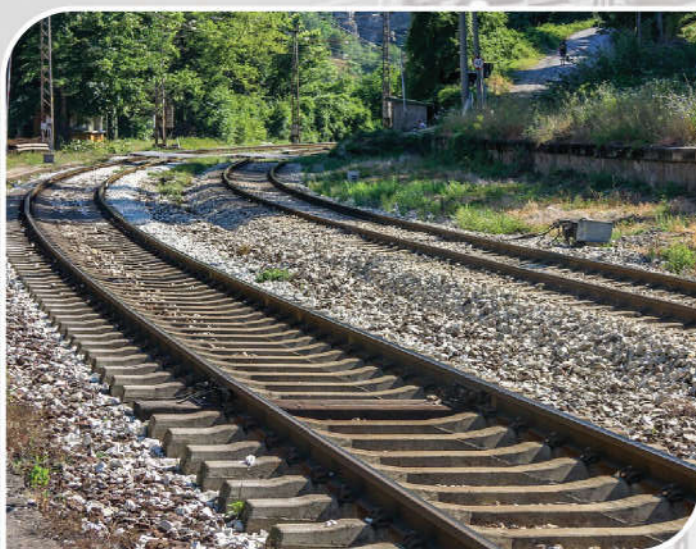

## NAM ANH GROUP

Transportation fields  
Profession in supplying and installing technology products for bridges, tunnels, railway.

### Bridge bearing

Rubber bearing; Pot bearing; Disk bearing; Spherical bearing; Damping bearing; STU (LUD)...

### Expansion Joint

### Pre-stressed system

### Asphalt concrete additives for anti-wheel rutting

### Cable system

Tie cable, hanger cable, stayed cable, hanger cable

### Waterproofing

Waterproof for tunnel, bridge, civil and industrial housing

### Transportation safety systems

Guardrail, noise barriers, anti-glare system

### Supplying ventilation, dust filter for tunnel

### Railway

Rail, switch, structure steel, accessories... for railway

### Lighting system

Traffic lighting system, architectural lighting system

### Geo textile, Geo fabric, soil nail

### Supplying special and modern equipment

Inspectional bridge truck, tunnel excavation machine, form traveler, formwork...

### Hydraulic system

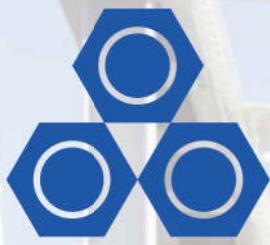

## RAILWAY

Nam Anh supplies materials and equipment for the railway industry such as rail, switch, railfish plate, sleeper, elastic accessories, rail keeper, railway nail, ...; along with structural steel, bolts, bearing for railway bridge, ...; Noise reduction and anti-vibration materials for railways.



Rail and accessories for railway



Switch



Accessories of railway



Noise reduction and anti-vibration materials for railways

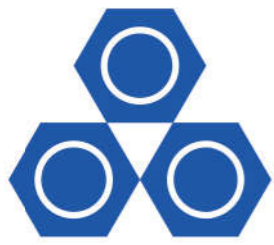

## TUNNEL

Provide special materials and accessories for tunnel construction.



Waterproof layer for tunnel



Lighting system, Dust collector and Fan ventilation system for tunnel



Special accessories for tunnel construction

# MAIN PRODUCTS FOR INFRASTRUCTURE FIELD



**NAM ANH GROUP**  
Technological Orientation To Make Difference



**POT BEARING**

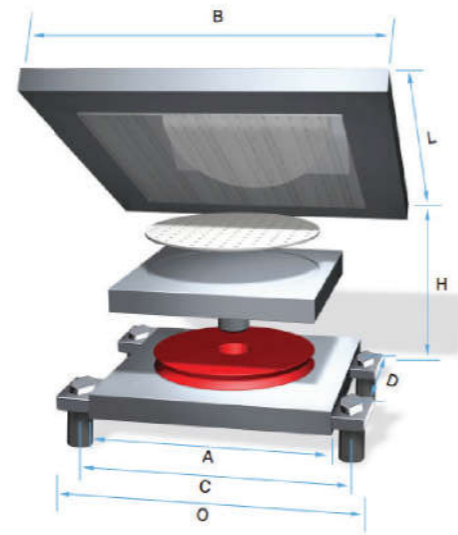

**DISK BEARING**



**LOCK - UP DEVICE**

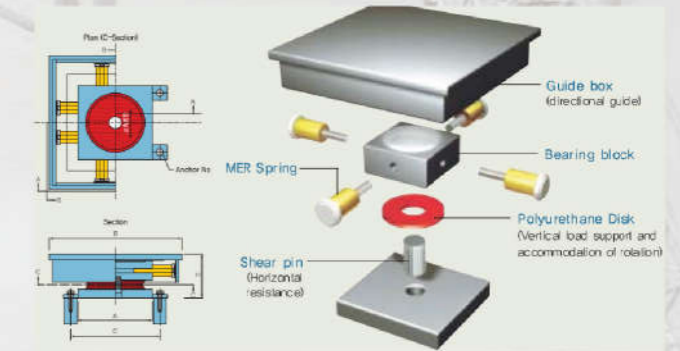

**ANTI-EARTHQUAKE BEARING**

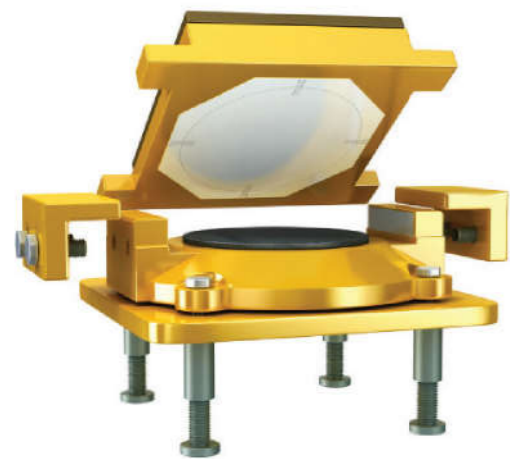

**SPHERICAL BEARING**

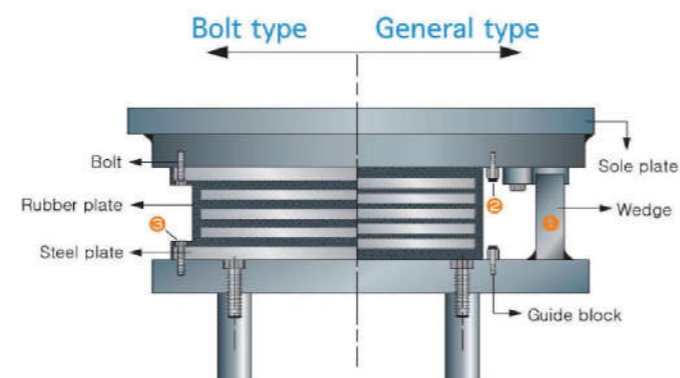

**RUBBER BEARING**

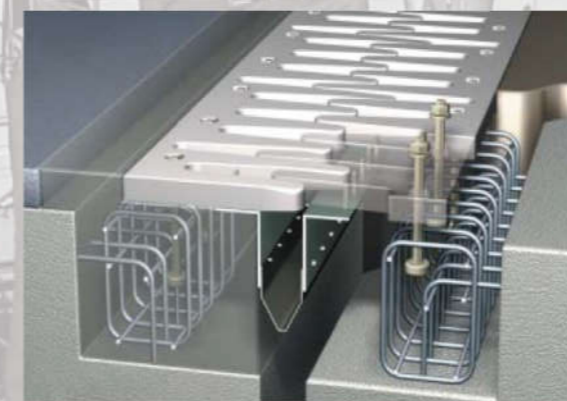

**FINGER JOINT**

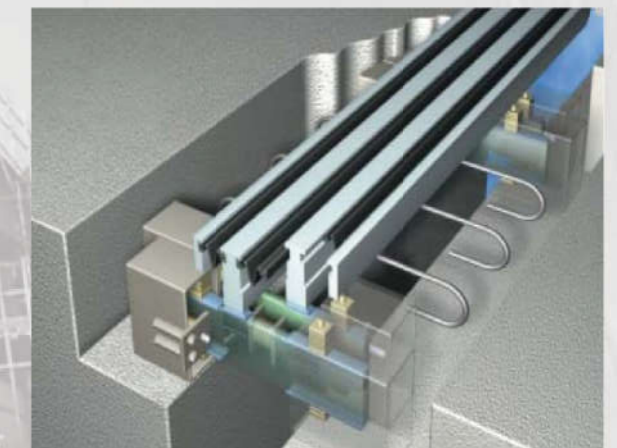

**COMPLEX RAIL JOIN**





**Not only a corporation specializing in supplying materials and equipment for the bridge industry, but also directly installation many projects**

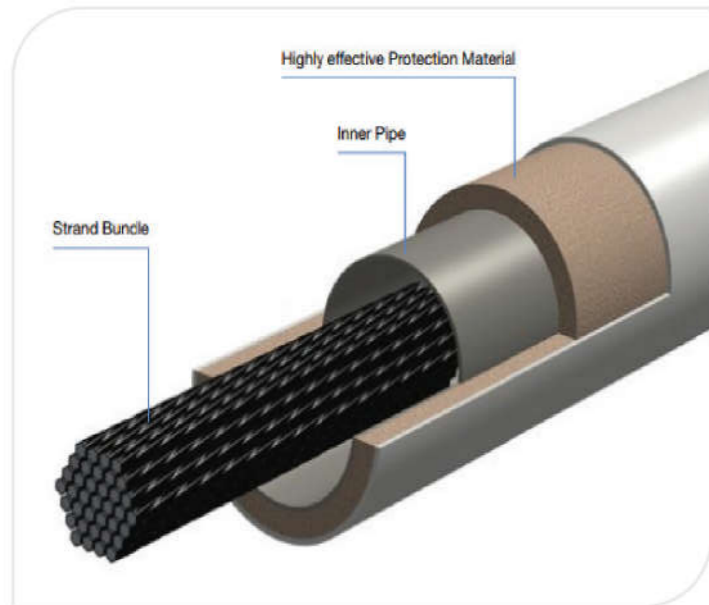

Cross section of MS cable system



PWS cable



Climbing formwork



Bridge Inspection Unit

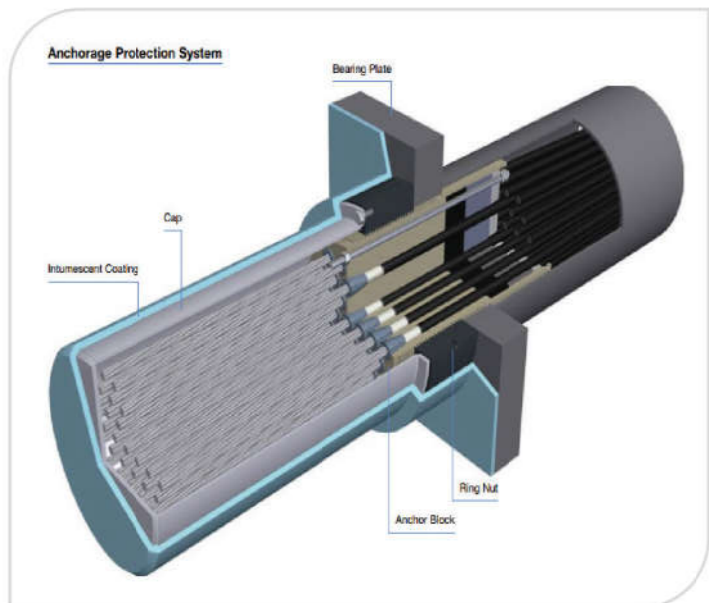

Anchorage for MS cable system

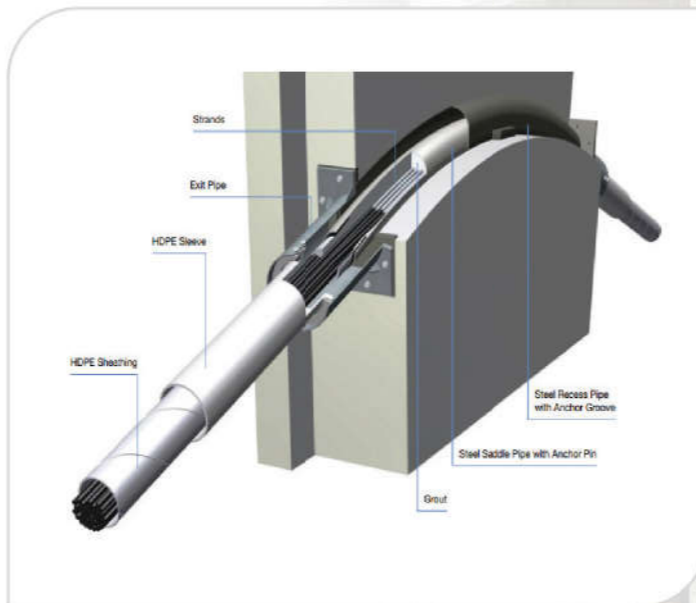

Saddle system

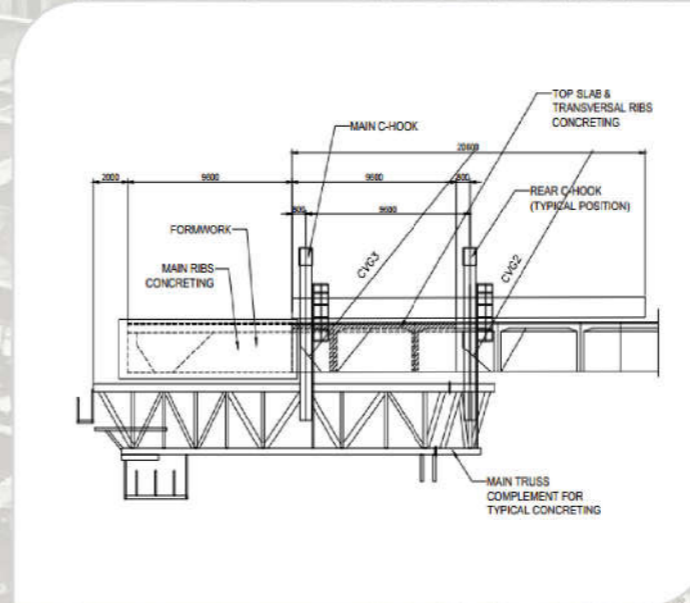

Form traveller



Form traveller

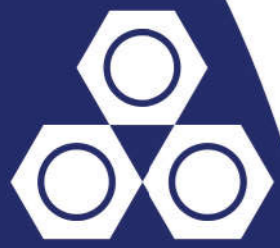

Noise barrier system



Traffic lighting system



Art lighting system

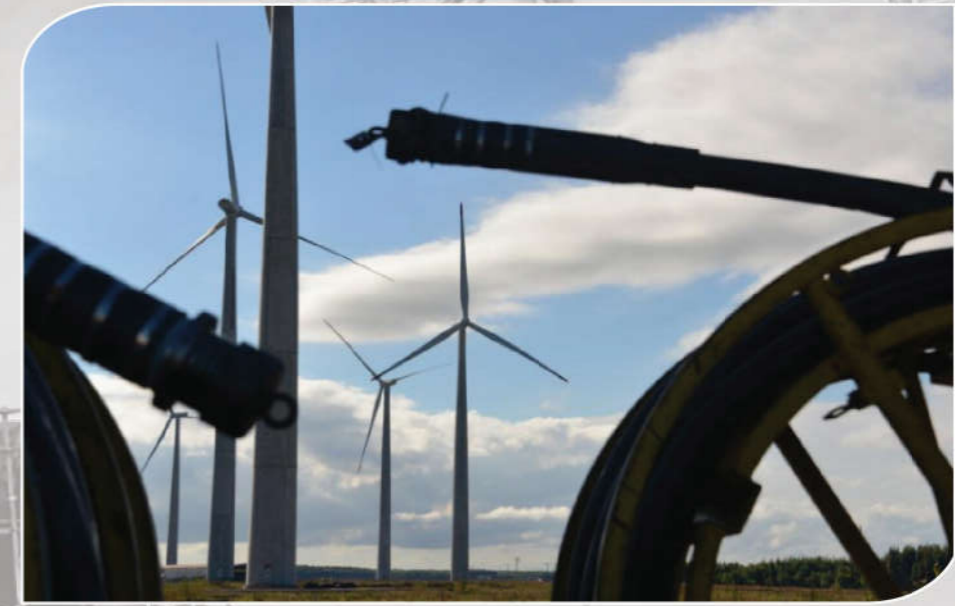

Cable for wind power construction



LNG storage tank



Anti-corrosion tape

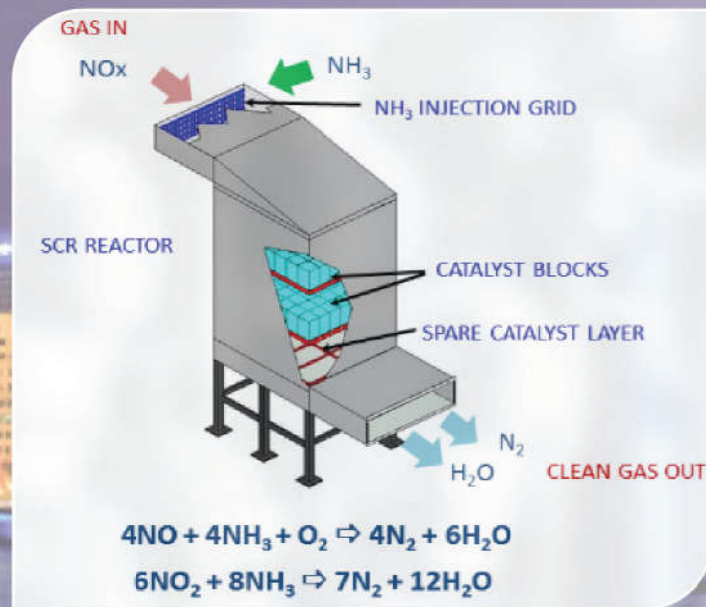

De-NOX  
SCR technology  
NSCR technology

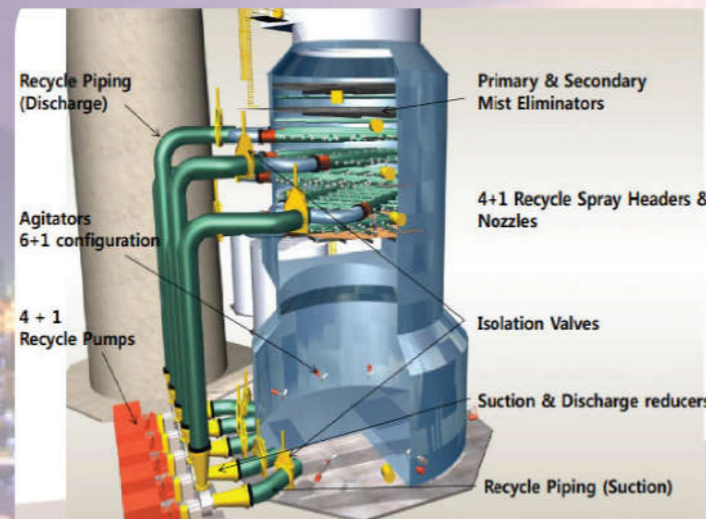

De-SO<sub>2</sub>  
Wet technology  
Semi-wet technology  
Dry technology



Fastener products



ESP



Fly ash separator

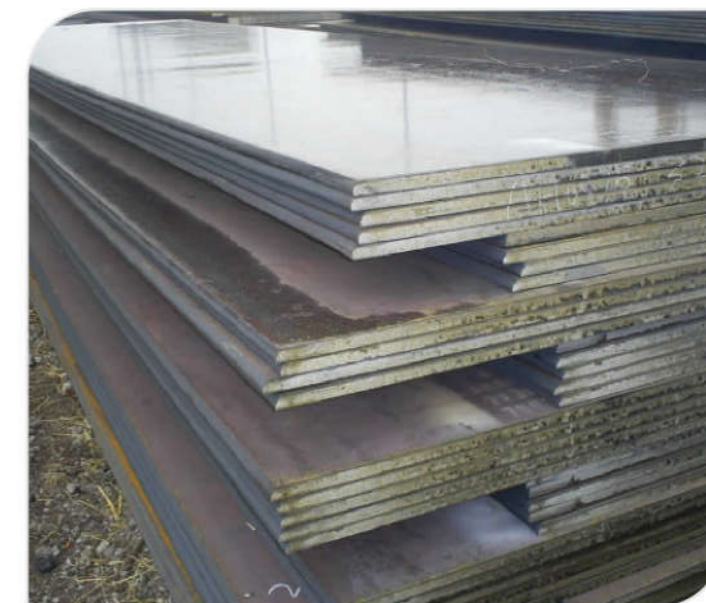

Steel products

# OTHER SPECIFIC TECHNOLOGY FIELD



**NAM ANH GROUP**  
Technological Orientation To Make Difference

Design, supply and install cable cars  
inclined lifts, zipline system.





## LIST OF PROJECTS

Nam Anh has joined and completed



### DONG TRU BRIDGE

Total length: 1240.0m  
Main span length: 500.0m  
Location: Ha Noi City - Completed: 2014  
Category: Supplying tie cable, hanger cable



### RACH CHIEC BRIDGE

Total length: 540.0m  
Main span length: 220.0m  
Location: Ho Chi Minh City - Completed: 2015  
Category: Supplying tie cable, hanger cable

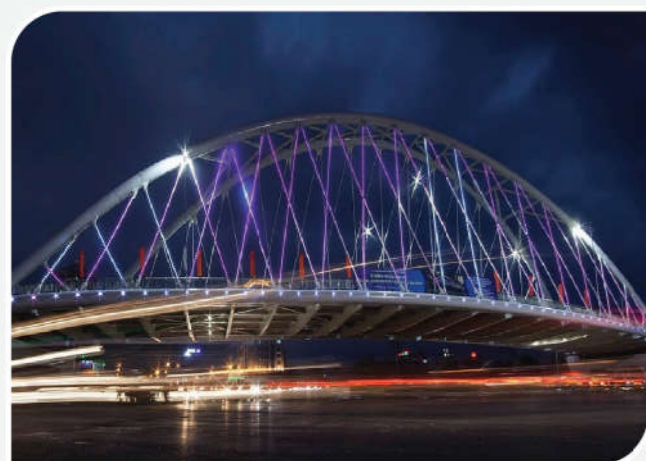

### LE HONG PHONG BRIDGE

Total length: 267.0 m  
Main span length: 99.0m  
Location: Hai Phong City - Completed: 2017  
Category: Supplying and installing hanger cable



### BEN TUONG BRIDGE

Total length: 384.0 m  
Main span length: 188.6 m  
Location: Thai Nguyen City - Under construction  
Category: Supplying tie cable, hanger cable



### HOANG VAN THU BRIDGE

Total length: 1570.0 m  
Main span length: 290 m  
Location: Hai Phong City - Under construction  
Category: Supplying tie cable, hanger cable



### TRA LY BRIDGE

Total length: 740.0m  
Main span length: 256.0m  
Location: Thai Binh province - Completed: 2017  
Category: Supplying and installing stayed cable



### BACH LAM BRIDGE

Total length: 455.0m  
Main span length: 270.0m  
Location: Yen Bai City - Under construction  
Category: Supplying and installing stayed cable



### NGUYEN VAN LINH BRIDGE

Total length: 288.2m  
Main span length: 100m  
Location: Hai Phong City - Under construction  
Category: Supplying and installing hanger cable



### CUA DAI BRIDGE

Total length: 3700m  
Main span length: 1800m  
Location: Quang Ngai Prov - Under construction  
Category: Supplying and installing stayed cable



**NAM ANH GROUP**  
Technological Orientation To Make Difference

## TYPICAL PROJECTS



## PARTNERS - CUSTOMERS

